

# Build the Station Simulation

---

## Educator's Guide



# **Build the Station Simulation**

## Educator's Guide

This document was created for the National Aeronautics and Space Administration by NASA Headquarters and Johnson Space Center.

Materials found within this document are in the public domain and are not subject to copyright requirements.

*Cover Picture:*

The International Space Station orbits above Earth's surface.



# Build the Station Simulation

## Table of Contents

---

---

Introduction . . . . .	3
National Standards . . . . .	4
About the International Space Station (ISS). . . . .	4
Parts of the Station Fact Sheet . . . . .	5
Science on the Station Fact Sheet . . . . .	7
International Partners Fact Sheet. . . . .	8
International Space Foods Fact Sheet . . . . .	10
Fun Station Facts . . . . .	11
International Space Station Summit Teacher Directions . . . . .	12
Materials . . . . .	12
Parts of the Model. . . . .	13
Space Station Operations and Mission Control . . . . .	14
Build the Station Simulation: Team Directions . . . . .	17
Station Simulation Worksheet . . . . .	31
Pre-/Post-Test . . . . .	32
Extensions . . . . .	33
Answer Keys . . . . .	35
Easy Ways To Obtain NASA Educational Materials . . . . .	37



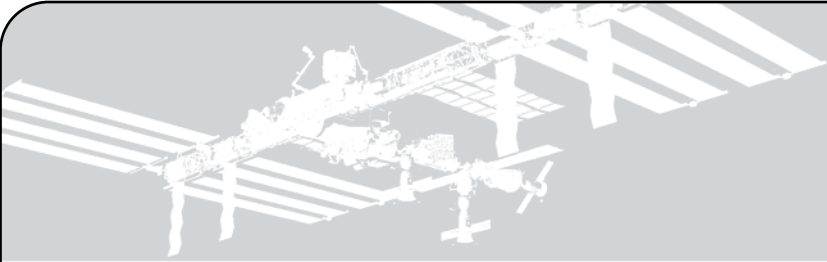

## Introduction

---

With just a few materials, building a paper model of the International Space Station (ISS) can become an excellent group, troop, or class project. This publication contains a brief overview of the ISS, its parts, the science that occurs on board, instructions, and extensions for an interdisciplinary technology experience. Discover more about the Station. Explore fun facts, simulate building the Station, and learn about the international partners.

NASA hopes to whet users' appetites for more space exploration through these materials. Teams of students can take on the roles of international partners and/or engineers as they learn about and assemble portions of the model. Once each team briefs the group about their section of the model during a mock summit, then it's time to ensure "Assembly Complete." Also included is a worksheet with Web links (and an answer key) to help students process what they learn.

The end result is an international, team-building experience to construct a 3-D paper model of the Station. With a bit of nylon fishing line or string, the model can hang suspended and seemingly float below the ceiling. Various links to multimedia experiences are included to extend the experience and further bring the Station to life. Students can visit the links to play a spacewalking simulation game, find out how to view the Station from their backyard, and see pictures of the inside of the Station using a program called Photosynth.

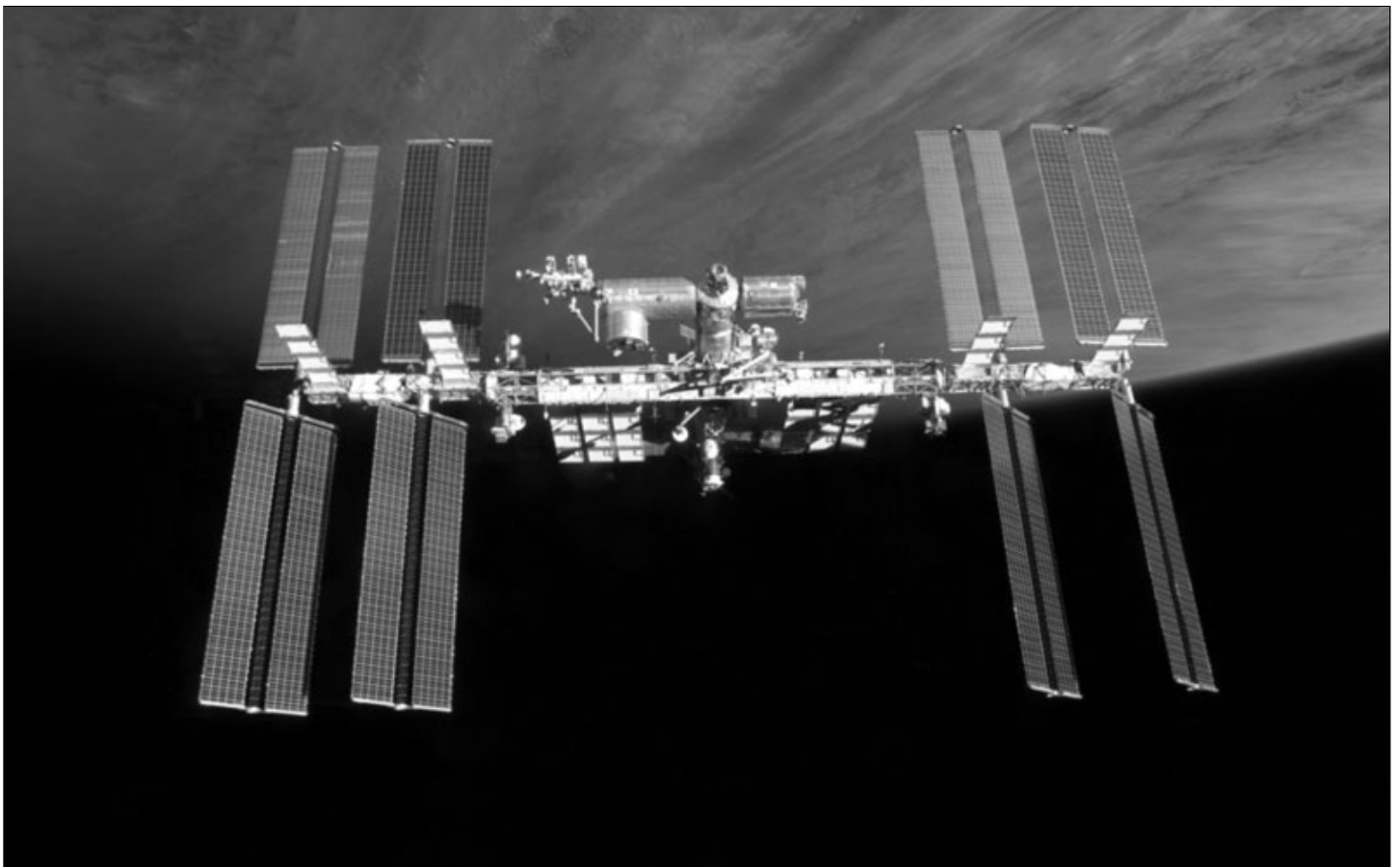

*The International Space Station orbits Earth against the inky blackness of space.*

## National Standards

---

This product meets the *National Science Education Standards* by the National Research Council.

### Science and Technology

K-12: Abilities of technological design.

K-12: Understanding about science and technology.

### Science in Personal and Social Perspectives

5-8: Science and technology in society.

9-12: Science and technology in local, national, and global challenges.

This product meets the *Standards for Technological Literacy* by the International Technology Education Association.

### The Nature of Technology

Standard 1: Students will develop an understanding of the characteristics and scope of technology.

## About the International Space Station (ISS)

---

The ISS is the largest and most complex international scientific project in history. When it is complete in the year 2011, the ISS will represent a move of unprecedented scale off the home planet. Led by the United States, the ISS also draws upon the scientific and technological resources of four international partners: Canada, Japan, Russia, and the European Space Agency.

More than four times as large as the Russian Mir space station, the completed ISS will have a mass of about 1,040,000 pounds. It will measure 356 feet across and 290 feet long, with almost an acre of solar panels to provide electrical power to six state-of-the-art laboratories. Amazingly, the ISS appears as the third-brightest object in our sky after the Sun and Moon.

NASA and its international partners hope that scientific research planned for six separate space laboratories will lead to discoveries in medicine, materials, and fundamental science that will benefit the people of Earth. Experimentation in space will advance our understanding of technologies required for further space exploration and possible habitation. Planned research includes studies of protein crystals, tissue cultures, life in low gravity, and the behavior of materials in space, as well as exterior studies of the space environment.

For more information about the International Space Station, visit [http://www.nasa.gov/mission\\_pages/station/main/](http://www.nasa.gov/mission_pages/station/main/).



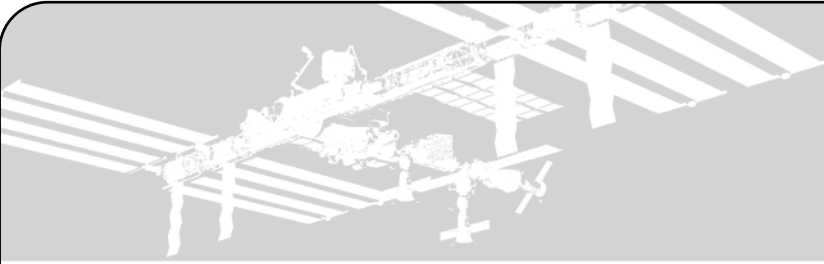

## Parts of the Station Fact Sheet

---

**Total length:** 354 feet

**Total width:** 240 feet

**Total mass:** 759,222 pounds

**Altitude:** 220 statute miles

**Average speed:** 17,239 mph

**Time to orbit Earth:** 91 minutes

### Modules

#### Columbus

**Launch date:** February 7, 2008

**Length:** 22.6 feet

**Mass:** 45,550 pounds

**Purpose:** Scientific research

**Origin:** Europe

#### Destiny

**Launch date:** February 7, 2001

**Length:** 30.2 feet

**Mass:** 52,962 pounds

**Purpose:** Scientific research

**Origin:** United States

#### Node 2—Harmony

**Launch date:** October 23, 2007

**Length:** 24 feet

**Mass:** 31,500 pounds

**Purpose:** Utility hub, central connection point for Station components

**Origin:** United States

#### Kibo—Hope

**Launch Date:** July 15, 2009

**Length:** 36.7 feet

**Mass:** 33,000 pounds

**Purpose:** Scientific research

**Origin:** Japan

#### Multipurpose Laboratory Module (MLM)—Nauka

**Launch date:** March 2010

**Length:** 42.7 feet

**Mass:** 41,887 pounds

**Purpose:** Scientific research

**Origin:** Russia

#### Mini-Research Module 2 (MRM2)—Poisk

**Launch date:** November 12, 2009

**Length:** 13 feet

**Mass:** 8,091 pounds

**Purpose:** Space for scientific experiments, airlock

**Origin:** Russia

#### Mini-Research Module 1 (MRM1)—Rassvet

**Launch date:** May 2010

**Length:** 18 feet

**Mass:** 10,362 pounds

**Purpose:** Cargo storage and docking

**Origin:** Russia



*The Station view of JAXA's laboratory, Kibo.*

### Node 3—Tranquility

**Launch date:** February 2010

**Length:** 21 feet

**Mass:** 41,887 pounds

**Purpose:** Onboard environmental support, observation of Earth through Cupola station

**Origin:** Europe/United States

### Node 1—Unity

**Launch date:** December 1998

**Length:** 18 feet

**Mass:** 26,225 pounds

**Purpose:** Life support and passageway to other areas of ISS

**Origin:** United States

### Functional Cargo Block—Zarya

**Launch date:** November 20, 1998

**Length:** 42.6 feet

**Mass:** 55,045 pounds

**Purpose:** Storage and propulsion

**Origin:** Russia

### Service Module—Zvezda

**Launch date:** July 11, 2000

**Length:** 43 feet

**Mass:** 54,242 pounds

**Purpose:** Communications center, storage

**Origin:** Russia

### Truss Segments

**Launch dates:** 2000–09

**Total Length:** 365 feet

**Mass:** Ranging from 19,227 pounds to 32,000 pounds

**Purpose:** Attachment points for solar arrays, radiators, and external experiments

**Origin:** United States



*An astronaut installs the Cupola to Tranquility Node.*

### Solar Array Panels

**Launch dates:** 2000–09

**Length:** Each wing (2 panels) is 115 feet long with 32,800 solar cells that produce 32 kilowatts of electricity—enough to power 16 homes.

**Purpose:** Converting sunlight to electricity

### Radiators

**Launch dates:** 2000–07

**Purpose:** Removing heat

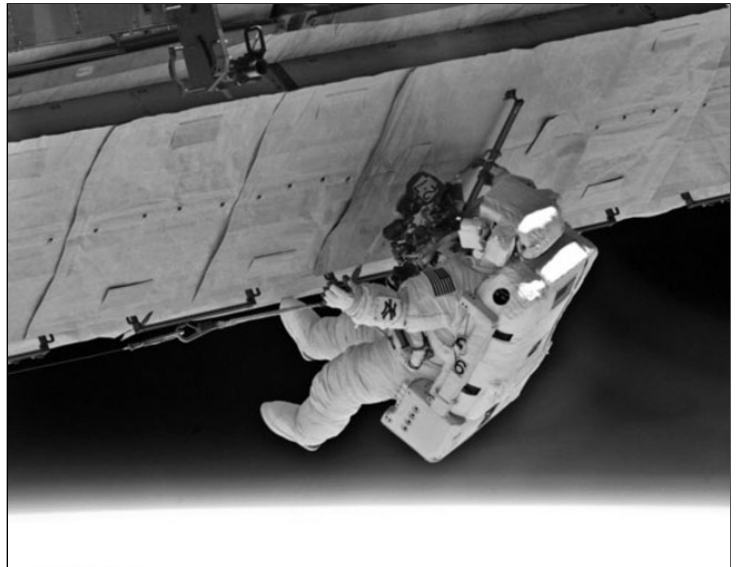

*An astronaut grips a handrail on part of the Truss.*

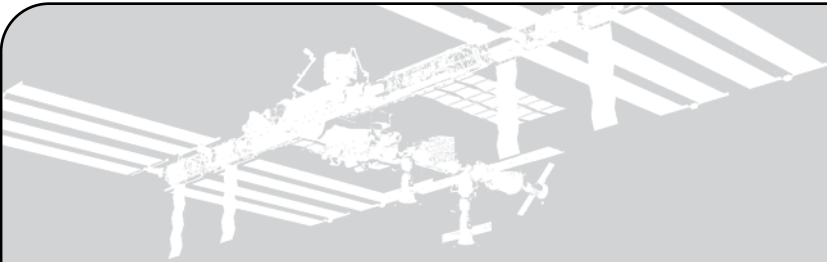

## Science on the Station Fact Sheet

---

### **Science on the International Space Station**

Scientific research on the ISS is done in areas called racks. Each rack can hold a number of experiments, each of which has the possibility of uncovering new and interesting facts about our universe every day. Some of these experiments include the following:

**Japanese Experiment Module—Exposed Facility** is one of the outdoor “decks” of the Space Station. It allows experiments to be exposed to the hostile environment of space, then examined to see how space affected them. This research will help scientists and engineers design airplanes, spacecraft, and other items used on Earth to hold up better in harsh conditions.

[http://www.nasa.gov/mission\\_pages/station/science/experiments/JEM-EF.html](http://www.nasa.gov/mission_pages/station/science/experiments/JEM-EF.html)

**Combustion Integrated Rack** houses experiments to study how fire and combustion work differently in space than on Earth and will provide valuable information on fire prevention and suppression as well as energy creation.

[http://www.nasa.gov/mission\\_pages/station/science/experiments/CIR.html](http://www.nasa.gov/mission_pages/station/science/experiments/CIR.html)

**European Modular Cultivation System** allows astronauts to grow plants in a controlled, zero-g environment to see how they grow in space compared to how they grow on Earth.

[http://www.nasa.gov/mission\\_pages/station/science/experiments/EMCS.html](http://www.nasa.gov/mission_pages/station/science/experiments/EMCS.html)

**Human Research Facility** gives astronauts the ability to study the effects of long-duration space flight on humans. Equipment such as ultrasounds, heart monitors, and the Pulmonary Function System (which measures lung health) allow complete measurements of the health of the entire human body while in orbit.

[http://www.nasa.gov/mission\\_pages/station/science/experiments/HRF-1.html](http://www.nasa.gov/mission_pages/station/science/experiments/HRF-1.html)

**Cupola**, the Space Station’s “room with a view,” provides an opportunity to examine Earth using some of the largest windows ever flown on a human-occupied spacecraft. This will enable research on coastal changes, geology, and agriculture on Earth to be performed by astronauts in space.

<http://www.nasa.gov/centers/kennedy/stationpayloads/cupola.html>



*Taking pictures of Earth from the Cupola inside the Tranquility Node.*

## International Partners Fact Sheet

The United States has four international partners. They are the Canadian Space Agency (CSA), the Russian Federal Space Agency (Roscosmos), the Japan Aerospace Exploration Agency (JAXA), and the European Space Agency (ESA).

### Canadian Space Agency

The CSA is the Canadian government space agency responsible for Canada's space program.

The headquarters of the CSA and Mission Control for the robotic arm system are located in Quebec.



Canada contributed a robotic arm, also known as the Mobile Servicing System (MSS), to the Station. The MSS consists of three main elements: the Space Station Remote Manipulator System (SSRMS), known as Canadarm2; the Mobile Base System (MBS); and the Special Purpose Dexterous Manipulator (SPDM), known as Dextre, which is like a hand with fingers.

<http://www.space.gc.ca>

### European Space Agency (ESA)

ESA is an intergovernmental organization dedicated to the exploration of space, currently with 18 member countries. Headquartered in Paris,

ESA's member nations include France, Germany, Italy, the United Kingdom, Spain, Belgium, the Netherlands, Switzerland, Sweden, Denmark, Ireland, Norway, Austria, Finland, Portugal, Greece, Luxembourg, and the Czech Republic.

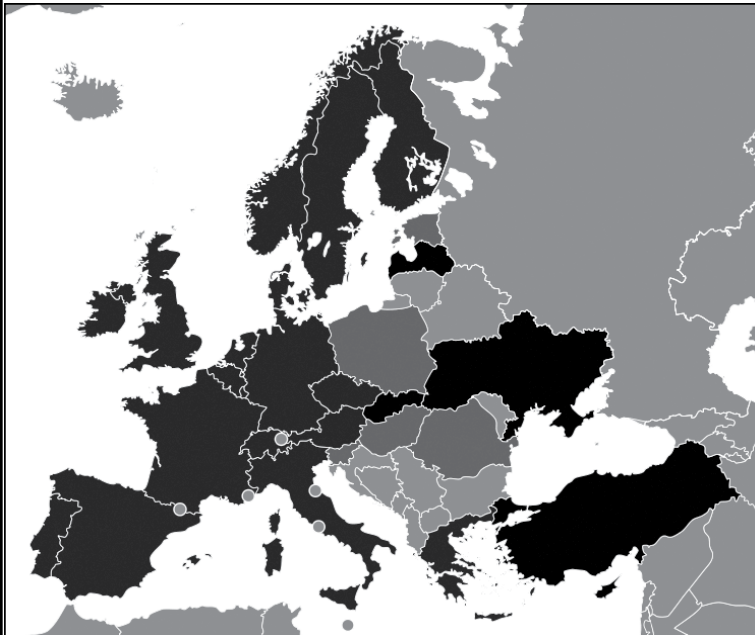

ESA's contributions to the ISS include the Ariane launch vehicle, the Columbus laboratory, a supply spacecraft known as the Automated Transfer Vehicle (ATV), and supply modules that were carried in the Space Shuttle cargo bay and were called Leonardo, Raffaello, and Donatello.

ESA science missions are based at the European Space Research and Technology Centre (ESTEC) in Noordwijk, Netherlands; ESA Mission Control (ESOC) is in Darmstadt, Germany; and the European Astronaut Centre (EAC) that trains astronauts for future missions is situated in Cologne, Germany.

<http://www.esa.int>

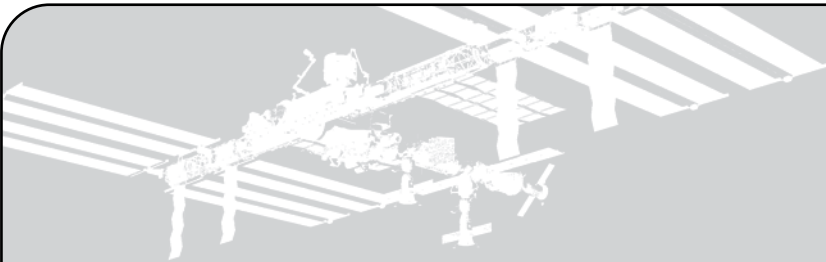

### Japan Aerospace Exploration Agency (JAXA)

JAXA is Japan's national aerospace agency. The headquarters is located in Tokyo, with the primary spaceport in Tanegashima Space Center and the Tsukuba Space Center in Tsukuba Science City.

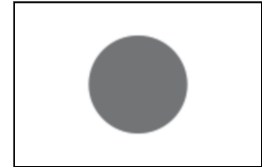

Japan has provided a rocket, a supply spacecraft called the H-II Transfer Vehicle (HTV), and a laboratory called Kibo (Hope) to the International Space Station. Refer to the Parts of the Station Fact Sheet for additional information.

[http://www.jaxa.jp/index\\_e.html](http://www.jaxa.jp/index_e.html)

### National Aeronautics and Space Administration (NASA)

NASA leads the United States' efforts for aeronautics and space exploration. Headquarters is based in Washington, DC, with 10 other Field Centers across the country:

- Goddard Space Flight Center, Greenbelt, MD
- Glenn Research Center, Cleveland, OH
- Langley Research Center, Hampton, VA
- Kennedy Space Center, Kennedy Space Center, FL
- Marshall Space Flight Center, Huntsville, AL
- Stennis Space Center, Stennis Space Center, MS
- Johnson Space Center, Houston, TX
- Ames Research Center, Moffett Field, CA
- Dryden Flight Research Center, Edwards, CA
- Jet Propulsion Laboratory, Pasadena, CA

NASA contributed the Space Shuttles, modules, nodes, solar arrays, radiators, and supply modules to the ISS. Refer to the Parts of the Station Fact Sheet for more information.

[www.nasa.gov](http://www.nasa.gov)

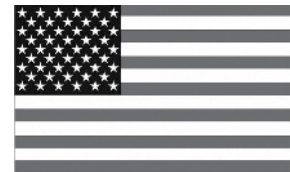

### Russian Federal Space Agency (Roscosmos)

Roscosmos is the government agency responsible for the Russian space science program and general aerospace research.

The headquarters of Roscosmos is located in Moscow. Main Mission Control is located in Korolev. The Gagarin Cosmonaut Training Center (GCTC) is in Star City. The launch facility used is the Baikonur Cosmodrome in Kazakhstan. Roscosmos provides the Proton rocket, the Soyuz spacecraft, the Progress supply spacecraft, laboratories, and modules to the Space Station. For more information, refer to the Parts of the Station Fact Sheet.

<http://www.roskosmos.ru>



## International Space Foods Fact Sheet

Astronauts in low-Earth orbit are far from friends and family. Maybe that is one reason that eating together is such a social occasion. On alternate days, meals are prepared from red (Russian) or blue (U.S. or European) bins. Space food must be light, take up little space, and have a long shelf life. Foods are not refrigerated, but water and heat are available to reconstitute food and drinks.

Here are examples of international foods served on board the ISS:

### United States

Beverage: Coffee  
Appetizer: Shrimp cocktail  
Main course: Fajitas with black beans and rice  
Dessert: Cherry/blueberry cobbler

### Russia

Beverage: Apricot juice  
Appetizer: Beet salad  
Main course: Beef goulash with mashed potatoes and onion  
Dessert: Honey cake

### Europe

Beverage: Iced tea (lemon or orange)  
Appetizer: Legumaise (mushroom truffle dip)  
Main course: Duck breast confit with capers  
Dessert: Rich chocolate cake

### Japan

Beverage: Green or oolong tea  
Appetizer: Soup with Wakame (seaweed)  
Main course: Mackerel with Miso sauce and rice  
Dessert: Sweet bread bean paste

### Canada

Main course: Salmon  
Dessert: Maple cookies  
Snack: Berry fruit bars



*Communal meals are a tradition. Food is strapped down with Velcro strips.*



*Fresh fruit and vegetables arrive with supply and crew deliveries.*



*Astronauts in fashionable international wear with the Russian Orlan and U.S. spacesuits.*

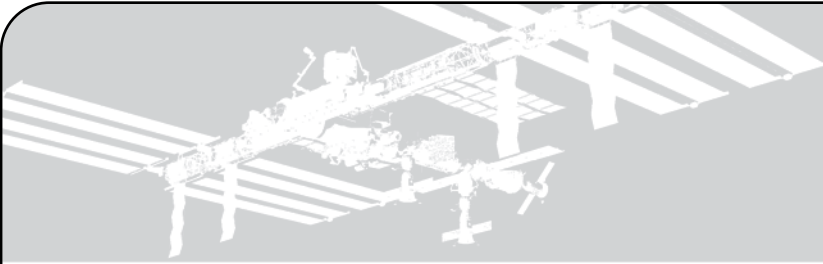

## Fun Station Facts

---

- The International Space Station (ISS) is the size of an American football field with the end zones included.
- Five member space agencies built the ISS: NASA (United States), Roscosmos (Russia), CSA (Canada), ESA (Europe), and JAXA (Japan).
- The ISS orbits between 250 and 300 miles above Earth's surface at a speed of 17,500 mph.
- Astronauts see 16 sunrises and sunsets a day as the ISS orbits Earth once every 90 minutes.
- The first piece of the ISS went up in 1998.
- A crew has continuously lived on board since the year 2000.
- The ISS won a trophy in 2010: the Collier Trophy, which is considered aviation's highest award.
- Amazingly, the ISS appears as the third-brightest object in our sky after the Sun and Moon.
- When complete, the ISS's habitable volume will equal the size of a three-bedroom house.
- There are two toilets on the Station, one Russian and one American.
- Each crew that arrives on the ISS rings a nautical bell when it boards and adds its mission patch sticker to the collection.
- Russian spacesuits are called Orlans. American suits are called Manned Maneuverability Units (MMUs). One enters the Orlan through the back; the MMU is donned in pieces.
- Launch vehicles that service the ISS include the Space Shuttle (United States), the Soyuz (Russia), the Automated Transfer Vehicle (ESA), and the HTV (Japan).
- Astronauts typically stay 6 months aboard the ISS per mission.
- The best view from the ISS is from the Cupola, which is a panoramic window installed on the Tranquility Node (Node 3).
- The amounts of time astronauts from various countries spend on board the Station are negotiated depending on the nations' contributions of hardware, supplies, and launch capabilities.

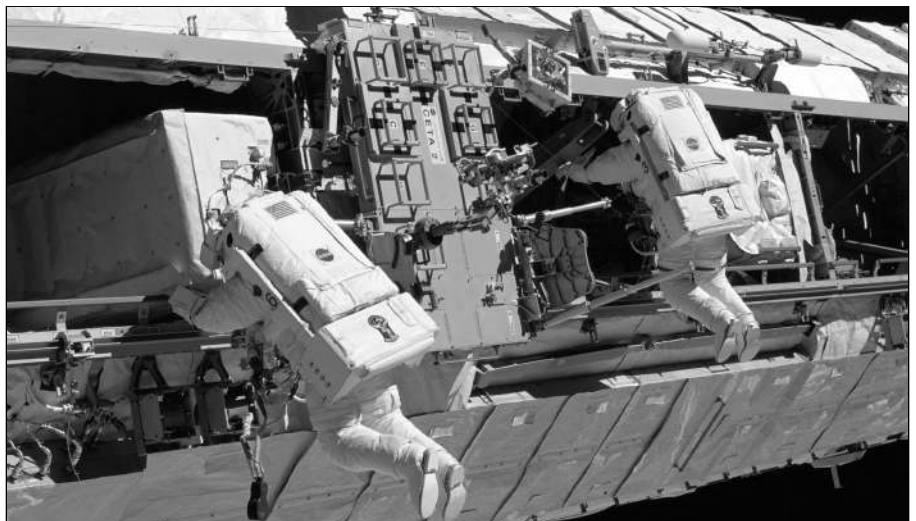

*Astronauts work on the Station's main Truss.*

## International Space Station Summit Teacher Directions

---

- Pass out fact sheets, worksheets, templates, instructions, and materials to teams of students. Teams should complete worksheets and build their section of the Station model.
- Have each team brief other teams on at least five interesting facts about their team's sections of the Station. This includes Parts of the Station, Fun Station Facts, International Partners, International Foods, and Science on the Station.
- Add pins to a large world map of member nations. Show where member nations are and where each agency's headquarters is located.
- Work together to assemble the parts of the Station (found on pages 15 through 27).
- Suspend the Station from the ceiling using nylon cord and a paper clip and tape.
- Plan to hold an international meal to celebrate the completion of the Station.

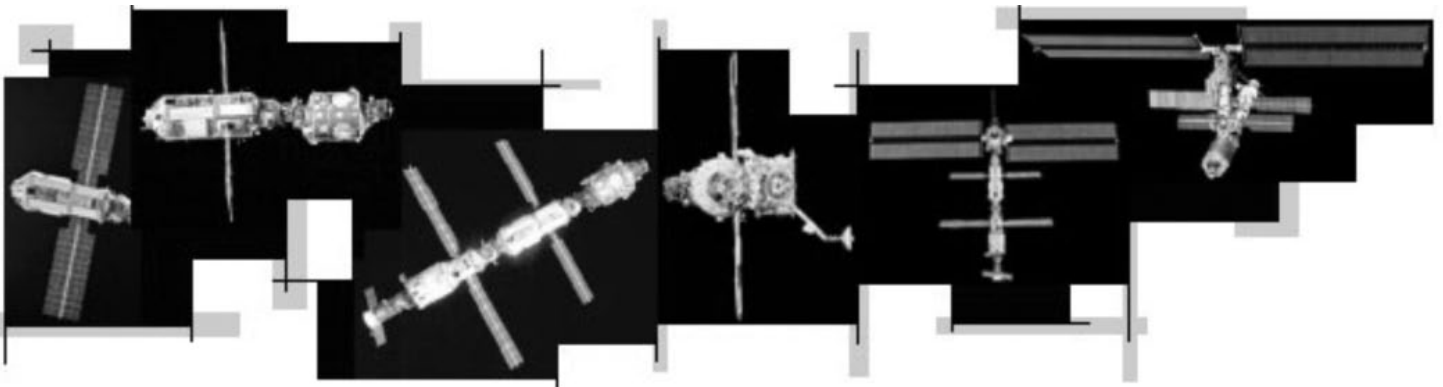

*A progression of images showing the first components of the ISS under construction.*

## Materials

---

Tools you will need:

- scissors
- tape
- glue (optional)
- heavy paper
- nylon fishing line
- wood skewers or ice pop sticks
- paper model templates
- fact sheets, pages 5 to 11
- worksheets, pages 29 and 30

First, you will need to print out the three sheets of parts on 8½" x 11" paper. A heavier paper will be a little easier to work with and will hold its shape better.

### Parts of the International Space Station

**Modules and Nodes**—These are the main areas of the ISS where astronauts live and conduct research.

**The Truss**—This acts as a support structure for the radiators and solar arrays.

**Solar Arrays and Radiators**—The arrays convert sunlight into power, while radiators cool the ISS by eliminating excess heat.





## Parts of the Model

1. Solar Panels
2. Radiators
3. Harmony
4. Destiny
5. Unity
6. Zarya
7. Zvezda
8. Quest Airlock
9. Zvezda Solar Panels
10. Truss
11. Russian Research Module (MRM2)
12. Columbus
13. Pressurized Mating Adapter
14. Kibo
15. Tranquility
16. Russian Research Modules (MRM 1) and Multipurpose Laboratory Module (MLM, not seen in photo)

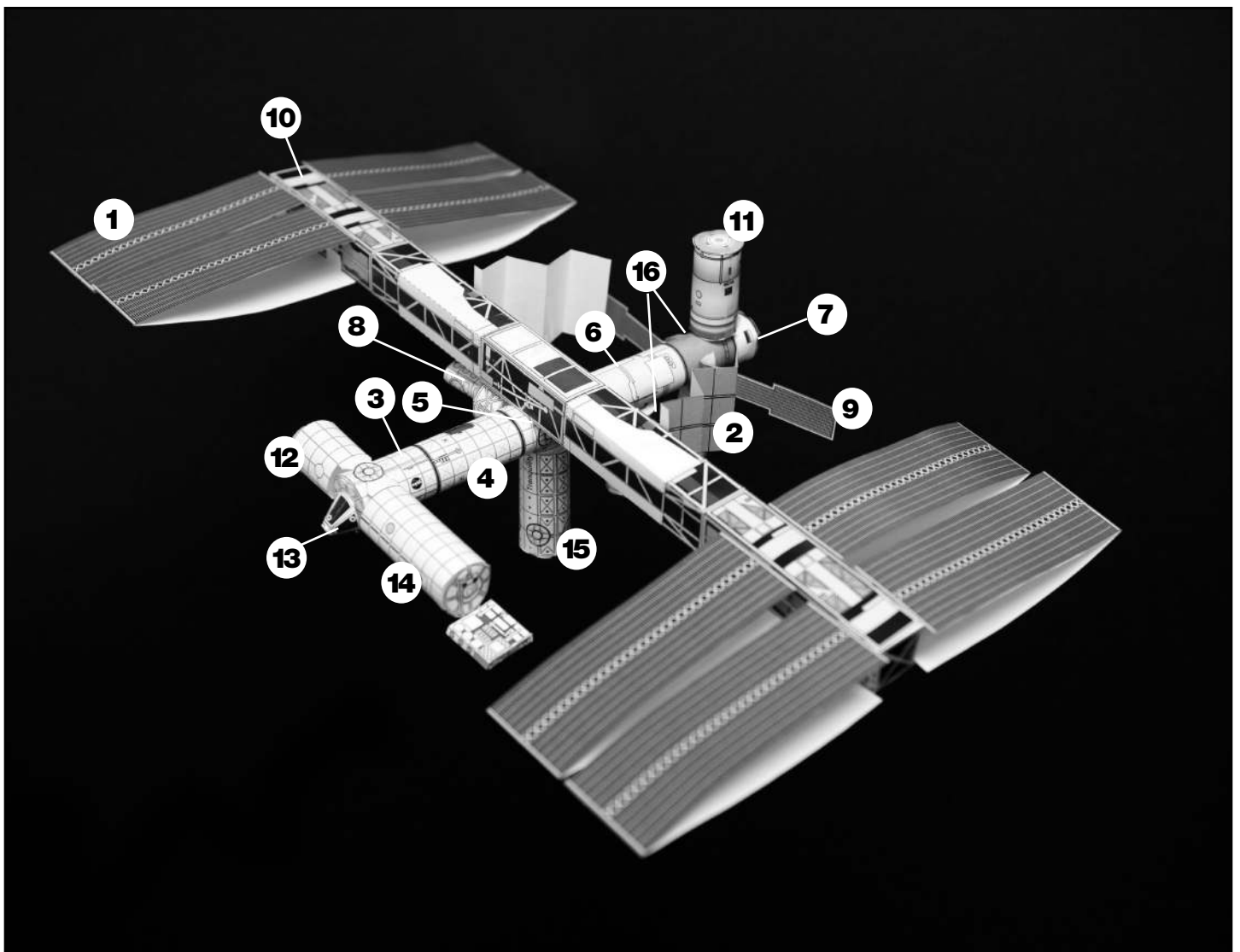

## Space Station Operations and Mission Control



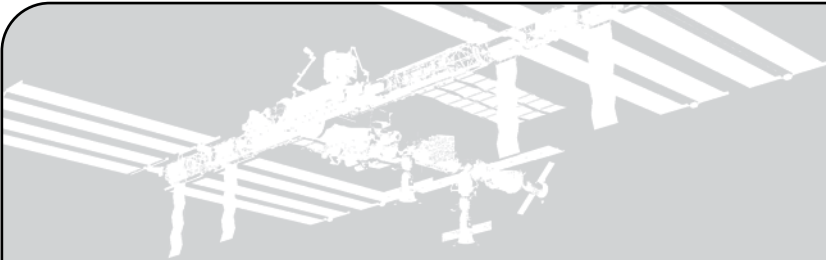



# Build the Station Simulation: Team Directions

## Team A: Roscosmos

### Materials:

- parts A, M, L, and K

Assemble parts A, K, L, and M; learn about the Russian and American parts of the Station that were the first to go up. Refer to the Parts of the Station Fact Sheet and complete the Team Worksheet. NOTE: The Harmony Node 2 was added after the last Truss section, but creative license is taken to add it to Team A. Components include the following:

1. Functional Cargo Block (Zarya)—Sunrise (A, K)
2. Node 1 (Unity) (A)
3. Service Module (Zvezda)—Star (A)
4. Destiny laboratory (A)
5. Remote Manipulator System—Canadian Robotic Arm
6. Quest Airlock (L, M)
7. Russian Docking Compartment and Airlock
8. Node 2 (Harmony) (A)

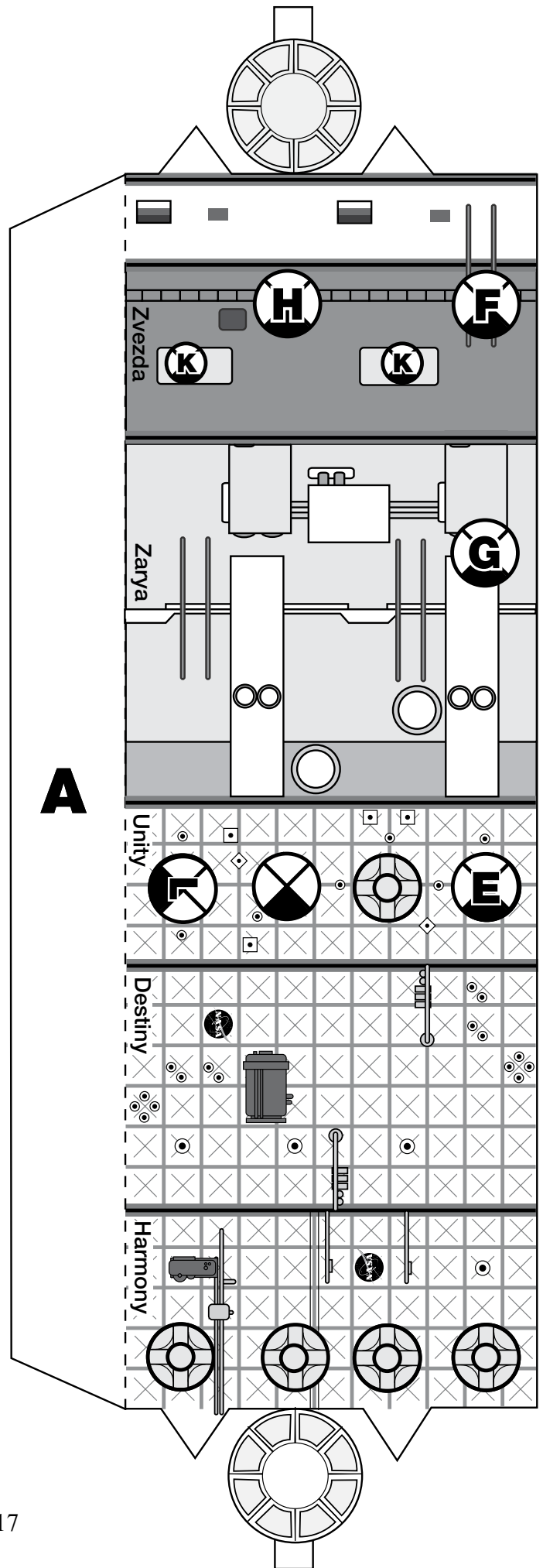
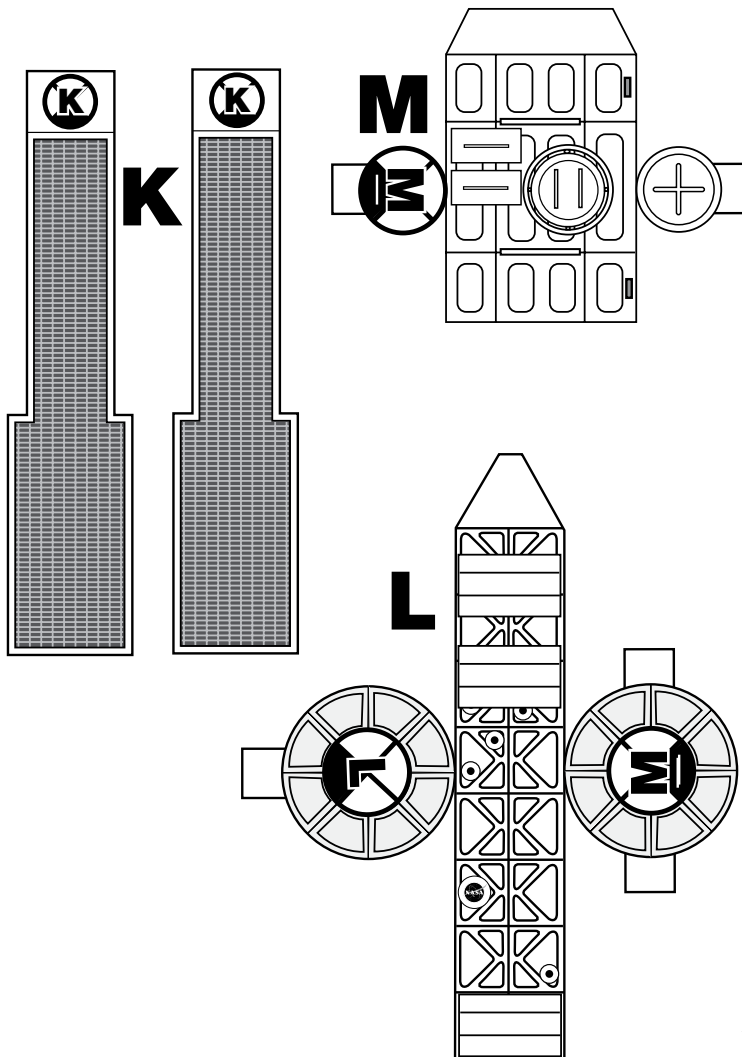



## Team B: NASA

### Materials:

- parts C, D, I, and J
- ice pop sticks or shish kebab skewers

Assemble parts C, D, I, and J. These are all American components. Refer to the Parts of the Station Fact Sheet. There are many sections to the Truss, each one completely filling the cargo bay of the Space Shuttle. Sections were added on alternating sides to balance the spacecraft. Solar Array Panels came collapsed like accordions and were unfurled a bit at a time. Refer to the Parts of the Station Fact Sheet and complete the Team Worksheet. Components include the following:

1. Zenith Truss (Z1) (C, D)
2. Port 6 Truss (P6) (C, D)
3. Starboard Zero Truss (S0) (C, D)
4. Starboard 1 Truss (S1) (C, D)
5. Port 1 Truss (P1) (C, D)
6. Port 3/4 Truss (P3/4) (C, D)
7. Port 5 Truss (P5) (C, D)
8. Starboard 3/4 Truss (S3/4) (C, D)
9. Starboard 5 Truss (S5) (C, D)
10. Radiators (I)
11. Solar Arrays (J/D)

The Truss acts as a support structure for the radiators and solar arrays.

### To Assemble the Truss:

1. Score along tick marks and roll/fold lengthwise, slipping flaps C and D on the inside of the roll. Glue or tape where the art lines up. Fold small square tabs on the ends to enclose the Truss.

2. Butt the two ends marked with  together, matching up the black pie-shaped quarters. This forms one long Truss. Glue or tape the ends together.

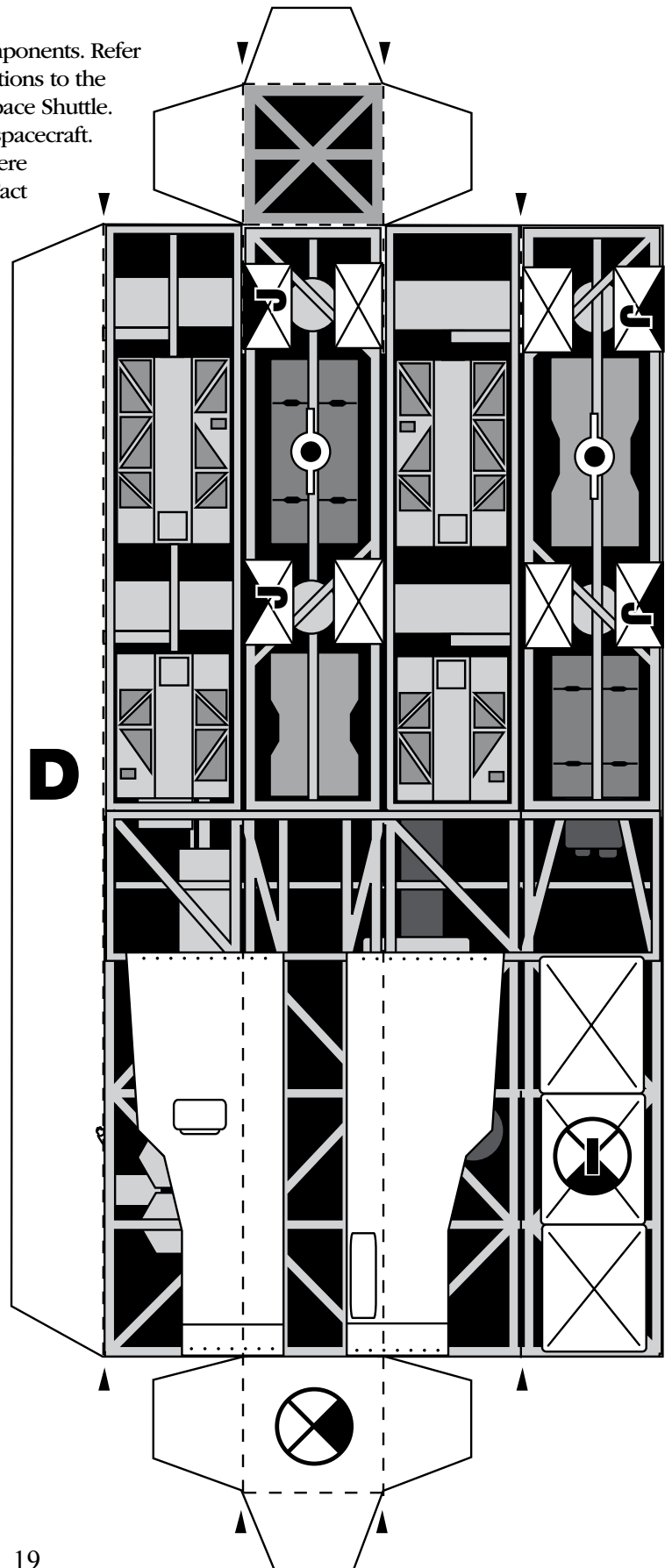
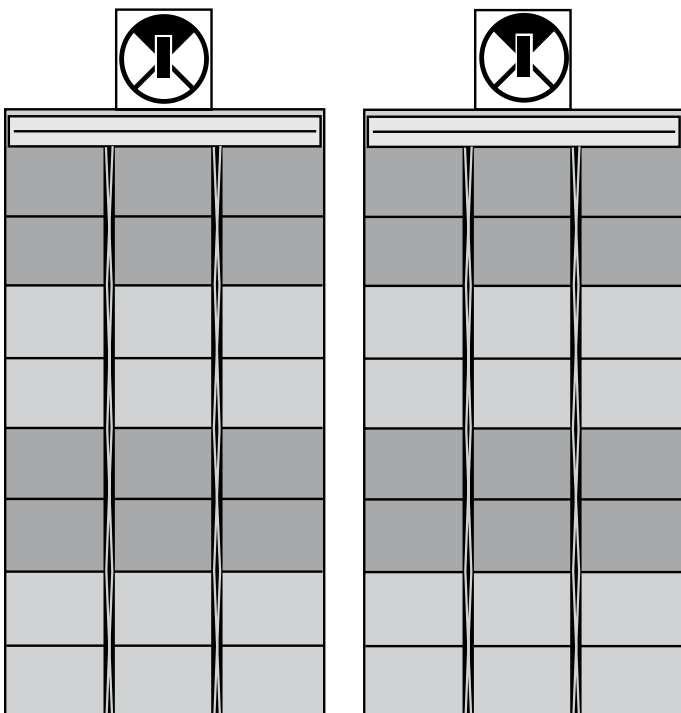







### Adding Solar Arrays and Radiators:

1. Cut out the Radiators (I), then score and fold along the lines where darker and lighter grays meet to make an accordion fold. See the illustration below.

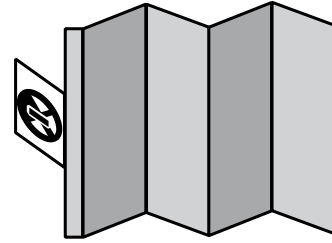
2. Glue and/or tape to the corresponding marks on the back side of the Truss. Make sure that the printed side faces outward.



3. Cut out the Solar Panels (J). It is recommended that you do not cut out the blank space between pairs because leaving them together will help to maintain their rigidity. To further help keep them from sagging, wooden shish kebab skewers or ice pop sticks about 4 inches long may be inserted through the middle of the Truss. Make the holes where the symbol  appears.

4. Fold the tabs up.

5. Fold the panels in half so that one set of tabs lines up with the other set. Quartered rectangles indicate where to glue and/or tape tabs to attach the Solar Panels (J) to both sides of the Truss. See the illustration below.

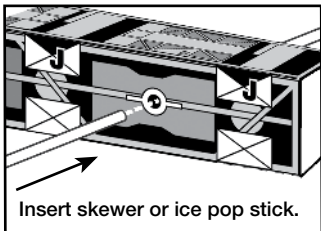

6. Tabs should be level with the top and bottom of the Truss.

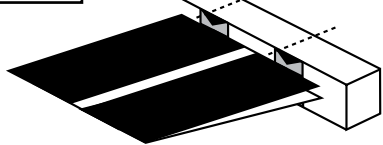



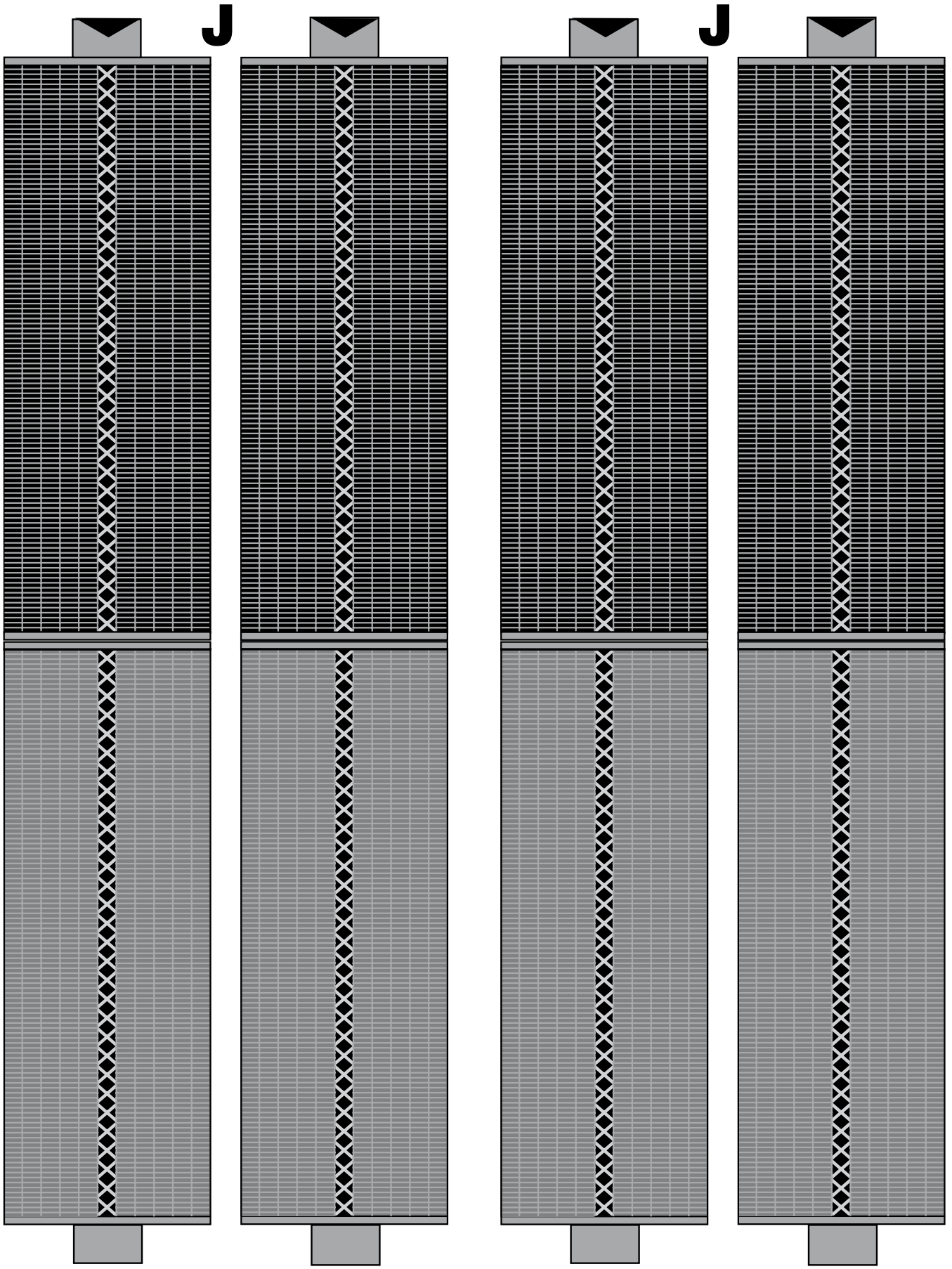



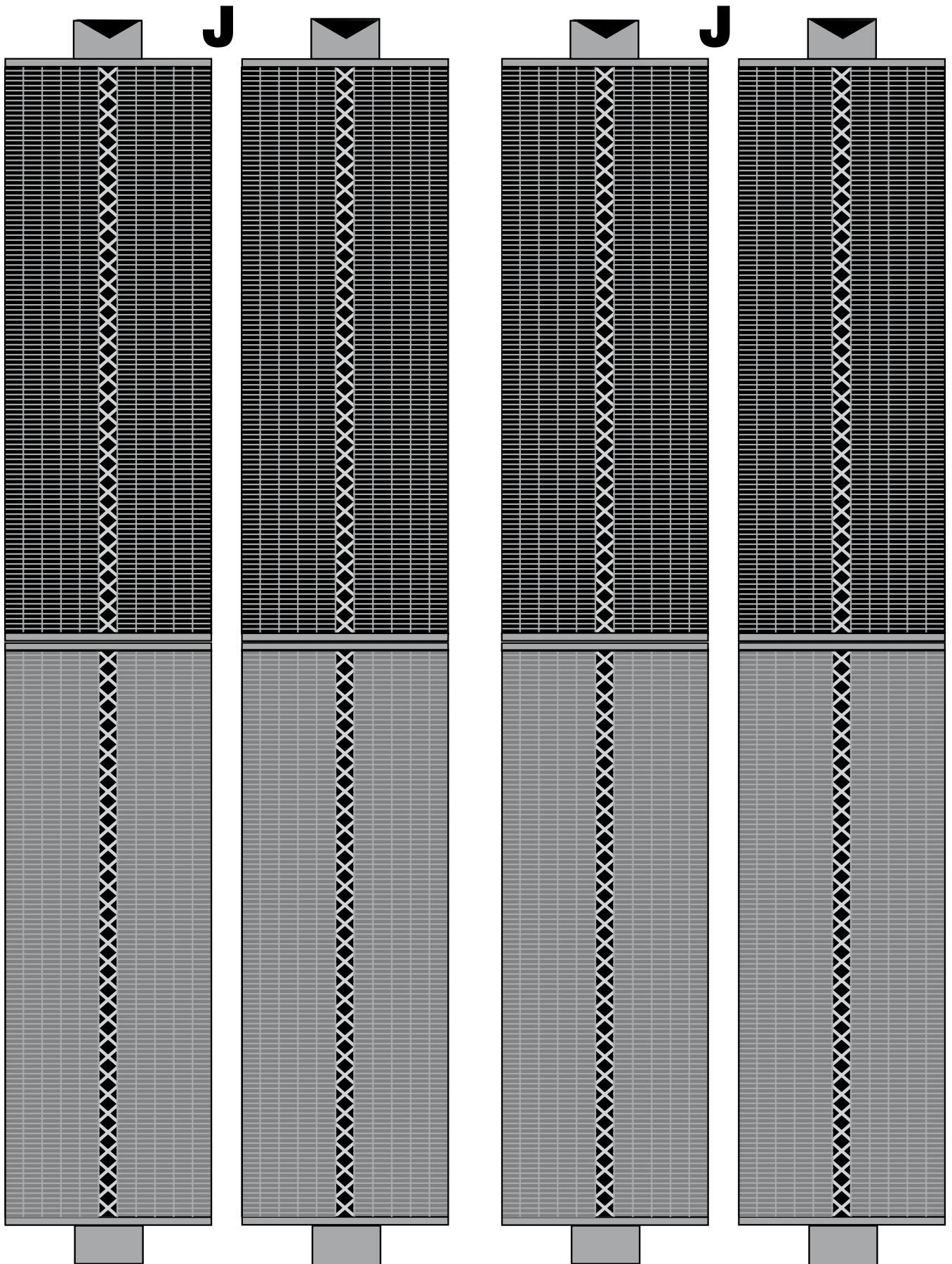



## Team C: ESA and JAXA

### Materials:

- parts B, E, F, G, H, and N

Assemble parts B, E, F, G, and H. The Space Shuttle docked at the pressurized mating adapter on part N through 2010, when the Station was completed. Refer to the Parts of the Station Fact Sheet and complete the Team Worksheet. Components include the following:

1. Columbus Laboratory (B)
2. Kibo Laboratory—Hope (B)
3. Japanese Experiment Module Pressurized Module (JEM—PM) and Canadian Robotic Arm Dextre (too small for model) (B)
4. Russian Multipurpose Laboratory Module (F)
5. Node 3 (Tranquility) and Cupola (E)
6. Russian Research Module (G, H)
7. Pressurized Mating Adapter (N)

1. Starting with the core group of modules (indicated by the flap labeled “A”), roll lengthwise, slipping the flap with the “A” printed on it on the inside of the roll, and glue and/or tape the flap where the printed art lines up. Fold the pointed end tabs in, as well as the small square tabs on the module ends, and glue and/or tape them shut to make an enclosed cylinder.

2. Follow the same procedure for modules E, F, G, and H. L and M are rolled and taped together in the same way as the Modules; then, tape the completed L and M components together on the underscored letters on each end to form the Airlock assembly.

3. For the Columbus and Kibo modules (B), follow the same procedure. After attaching the round ends of the cylinders, bend the outside experiment platforms (the flat tabs with machinery on them) outward to be flat, on the same plane as the modules. On the larger Kibo platform, use a paper clip or the edge of scissors to score the three sides at the notches, and fold those down to give the platform dimension.

4. Slide the side opening of the Columbus and Kibo modules over the end of the Harmony module so that they are perpendicular, line up the hatches, and tape and/or glue into place.

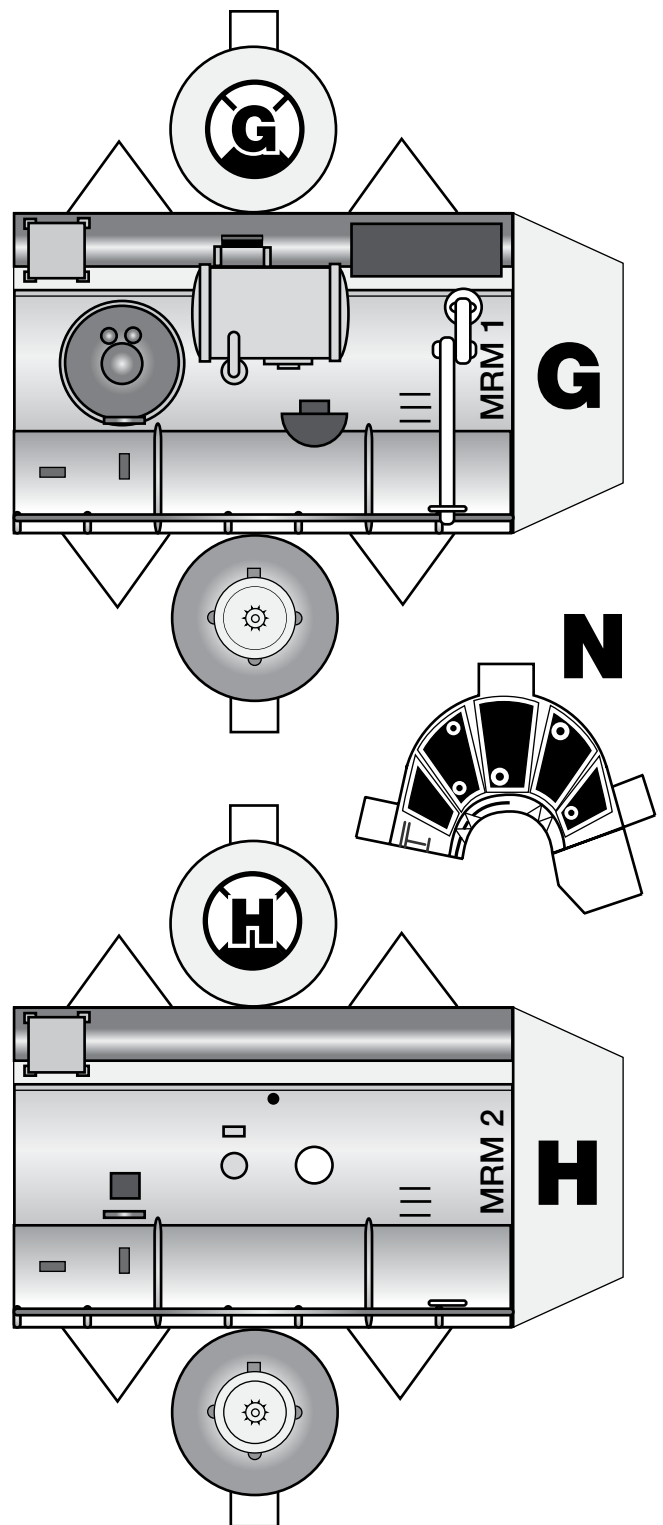
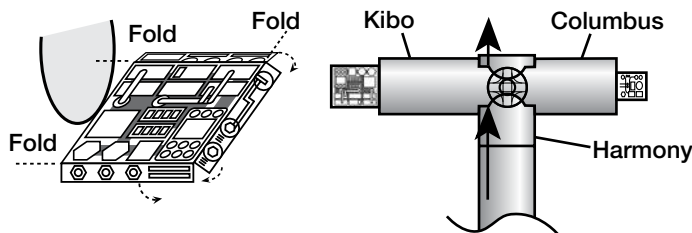





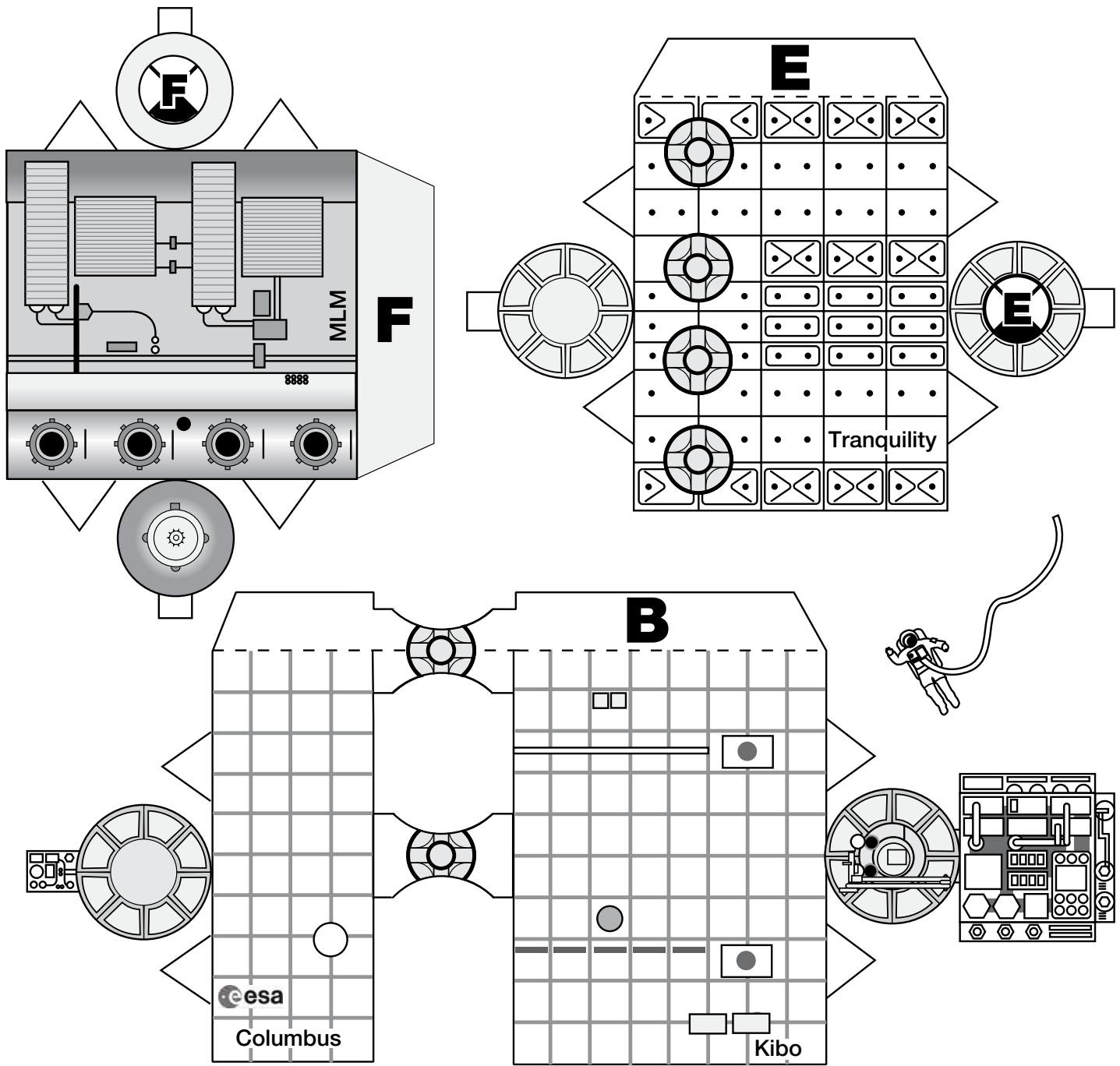

**Combining Modules and Truss:**

1. Match up the joining  spots on the bottom of the Truss and the top of the Unity module on the longest of the module cylinders. Match the black quarters together to get the correct orientation.
2. Use the nylon fishing line to hang the ISS from the ceiling.

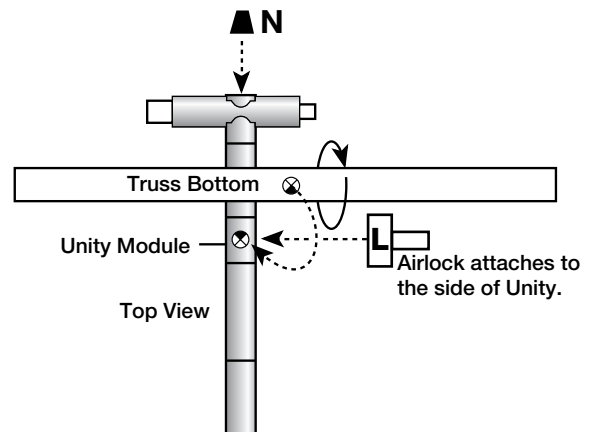
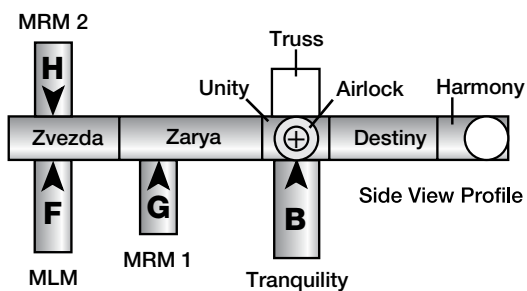



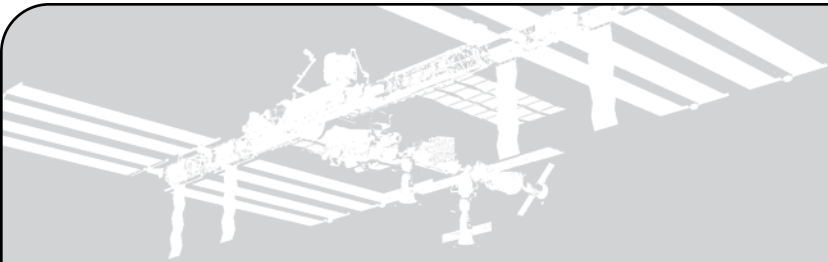

## Station Simulation Worksheet

---

Team: \_\_\_\_\_

Members: \_\_\_\_\_

1. Name three interesting facts your team learned about your parts of the Station.
2. Name two fun facts you learned about the Station from the Fun Station Facts sheet.
3. What international meal would you choose? (Include a beverage, appetizer, main course, and dessert.)
4. You are a scientist wanting to learn more about how to design a better smoke detector. Which Station experiment would you study?
5. Which experiment offers the best opportunity to take pictures of land and oceans on Earth?
6. Where would astronauts go to see how well they are breathing after 6 months in space?
7. Of the modules built, which one is longest?
8. Draw a flag of your nation.
9. Where is the headquarters of your team located? (Mark the headquarters on a world map.)
10. Who is on the Station now? What crew? What nations?

## Pre-/Post-Test

---

- \_\_\_ 1. How many international partners make up the International Space Station?  
a. 3            b. 5            c. 18            d. 22
- \_\_\_ 2. How often does the International Space Station go around the planet?  
a. Every 90 minutes    b. Every 30 minutes    c. Every 24 hours    d. Every 12 hours
- \_\_\_ 3. How far away does the International Space Station orbit?  
a. Halfway to the Moon            b. 90 miles            c. 300 miles
- \_\_\_ 4. The headquarters of the European Space Agency is in which city?  
a. Paris            b. Lisbon            c. Noordwijk            d. Quebec
- \_\_\_ 5. Which one is NOT a space agency?  
a. BSA            b. ESA            c. JAXA            d. NASA
- \_\_\_ 6. What part of the International Space Station did Canada contribute?  
a. The Columbus Lab            b. The Harmony Node            c. The Robotic Arm
- \_\_\_ 7. In which part of the Station do astronauts take the best pictures of Earth and its oceans?  
a. Zvezda            b. Kibo            c. Unity            d. Cupola
- \_\_\_ 8. How many airlocks are there for astronauts use to go outside for spacewalks?  
a. One            b. Two            c. Three            d. Four
- \_\_\_ 9. The European Modular Cultivation System allows astronauts to study  
a. Plants            b. Human tissues            c. Combustion            d. Materials science
- \_\_\_ 10. The biggest contributor to the International Space Station is which partner?  
a. Russia            b. United States            c. Europe            d. Japan

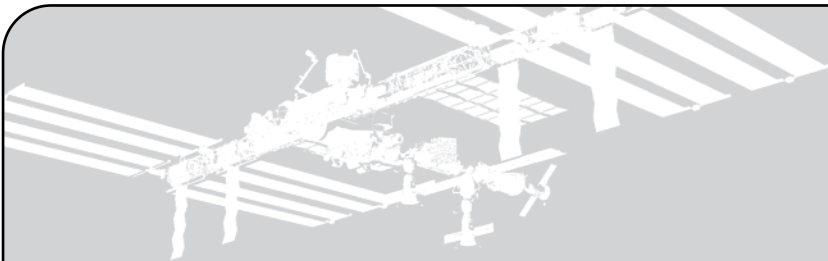

## Extensions

---

**Need more Station? Try these questions and activities.**

All of the following questions can be answered by visiting <http://www.nasa.gov/station>.

**Who Is On Board?**

What crewmembers are on board? What is the expedition number? What are the nationalities of the crew?

**See the Station.**

Find out when the Station is next visible from your backyard, then go view it.

**Play the Station Spacewalk Game.**

Find out what it's like to be an astronaut on a spacewalk by playing the Station Spacewalk Game. What was your mission, and what did you learn?

**Check Out ISS Photosynth.**

Complete the ISS Scavenger Hunt on the Photosynth site:  
<http://www.nasa.gov/externalflash/photosynth/index.html>

**Use the Interactive Space Station Reference Guide.**

Find out where the crew sleeps and where crewmembers exercise.

**Discover Future Missions.**

Find out what will be happening on the next mission to the Space Station. Name at least one mission objective.

# Notes

---

---

---

---

---

---

---

---

---

---

---

---

---

---

---

---

---

---

---

---

---

---

---

---

---

---

---

---

---

---

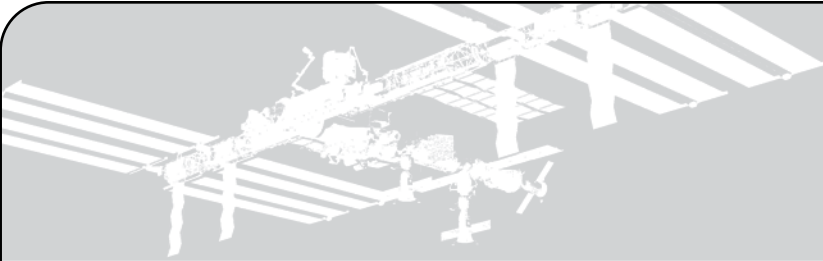

## Answer Keys

---

### Worksheet

1. Answers will vary. See Parts of the Station Fact Sheet.
2. Answers will vary. See Fun Station Fact Sheet.
3. Answers will vary. See International Space Food Fact Sheet.
4. Study the Combustion Integration Rack experiments.
5. Go take pictures from the Cupola attached to Tranquility Node.
6. The Human Research Facility studies the long-term effects of space on humans.
7. Zvezda is the longest module built.
8. Answers will vary. See International Partners Fact Sheet.
9. NASA Headquarters is located in Washington, DC. Roscosmos Headquarters is located in Moscow, Russia. ESA Headquarters is in Paris, France. JAXA Headquarters is in Tokyo, Japan.
10. To find out which Expedition crewmembers are on board the Station at any one time and their nationalities, visit [http://www.nasa.gov/mission\\_pages/station/expeditions/index.html](http://www.nasa.gov/mission_pages/station/expeditions/index.html).

### Pre-/Post-Test

1. b (5)
2. a (Every 90 minutes)
3. c (300 miles)
4. a (Paris)
5. a (BSA)
6. c (The Robotic Arm)
7. d (Cupola)
8. b (Two)
9. a (Plants)
10. b (United States)

### Extensions

Who Is On Board? Answers will vary.

See the Station: Dates will vary.

Play Station Spacewalk Game: There are seven games to try.

- Explore the Station
- Retrieve Your Tools
- Unfurl the S6 Solar Arrays
- Repair the Torn Solar Array
- Bring the Auxiliary Antennas On Line
- Install the S6 Truss
- Conduct the Spheres Experiment

Scavenger Hunt

Reference Guide: Crew Sleeps in Russian Service Module and U.S. Lab

Crew Exercises in Nodes 1 and 3

Future Missions: Answers will vary.







## Easy Ways To Obtain NASA Educational Materials

The NASA Office of Education works with NASA experts to promote education as an integral component of NASA research and development missions. These efforts result in innovative and informative educational materials that engage student interest in science, technology, engineering, and mathematics. NASA makes these resources available through the following ways:

- View and download educational resources from NASA's Web site: <http://www.nasa.gov/education>
- Visit a NASA Educator Resource Center (ERC): <http://www.nasa.gov/education/ercn>
- Purchase materials from the Central Operation of Resources for Educators (CORE): <http://www.nasa.gov/education/core>

### **Educational Multimedia**

NASA offers educational multimedia such as the Do-It-Yourself Podcast activity for students, video learning clips, Webcasts, monthly educational programming on NASA TV, and image galleries. View the following pages:

- Do-It-Yourself Podcast: <http://www.nasa.gov/education/diypodcast>
- NASA eClips (video learning clips): <http://www.nasa.gov/education/nasaclips>
- NASA's Digital Learning Network (Webcasts): <http://www.nasa.gov/education/dln>
- NASA Education TV Schedule: <http://www.nasa.gov/education/tvschedule>
- Image Galleries: <http://www.nasa.gov/education/galleries>

### **Alphabetical Lists of NASA Topics for Education**

The A–Z lists offer a fast way to find information about NASA topics, education pages for missions, and interesting pages for students.

View the following pages:

- Educators: [http://www.nasa.gov/education/edu\\_AZ](http://www.nasa.gov/education/edu_AZ)
- Students, 9–12: [http://www.nasa.gov/education/stu912\\_AZ](http://www.nasa.gov/education/stu912_AZ)
- Students, K–8: [http://www.nasa.gov/education/stuK8\\_AZ](http://www.nasa.gov/education/stuK8_AZ)

### **Find NASA Teaching Materials**

An online search tool helps educators locate materials for the classroom. Users may sort products by grade level, type of product, or topics.

Types of Materials:

- Bookmarks • Classroom Activities • Educator Guides • Lesson Plans • Lithographs (Images)
- Play and Learn • Posters • Program Brochures • Video Learning Clips • Web Sites

<http://www.nasa.gov/education/materials>

### **NASA Education EXPRESS Mailing List**

Sign up to receive e-mail announcements about NASA products, activities, workshops, events, and opportunities to bring NASA educational resources into your classroom: <http://www.nasa.gov/education/express>

### **NASA's Educator Resource Center Network**

NASA's ERCs are located throughout the United States, in the U.S. Virgin Islands, and in Puerto Rico. ERCs offer information about NASA and its educational resources and services. Personnel provide inservice and preservice training using NASA curriculum support materials. ERC team members also collaborate with educational organizations to foster systemic initiatives at local, state, and regional levels. Contact a NASA ERC for services in your area: <http://www.nasa.gov/education/ercn>

### **Central Operation of Resources for Educators**

CORE serves as the worldwide distribution center for NASA-produced educational multimedia materials. For a minimal charge, CORE provides curriculum support materials to educators who are not able to visit one of NASA's ERCs or who are looking for large quantities of materials. Educators can use CORE's online catalog and mail-order service to purchase NASA education materials. Products include activity kits, bulletin boards, CD-ROMS, DVDs, publications, slide programs, and videotapes. Closed-captioned and audio-descriptive versions of many materials are available: <http://www.nasa.gov/education/core>

